

Installation Manual

BISOL EasyMount™

Home HOOK



Solar company!



The **sunny** side of **life!**

TABLE OF CONTENTS

General Requirements	3
Components Overview	4
Tools Required	5
Planning the PV Layout	5
Project Design	5
Designing the PV Module Layout	6
Portrait Orientation	6
Landscape Orientation	7
Important Dimensions for Module Fields and Thermal Separation	8
Portrait Orientation	8
Landscape Orientation	8
Portrait module installation	9
Landscape module installation (using a profile grid)	10
Landscape module installation (using the L-connector)	10
Assembly	11
STEP 1: Removing Tiles	11
STEP 2: Mounting Hooks	11
STEP 3: Trimming and Repositioning Tiles	12
STEP 4: Mounting Profiles	12
Option 1 – STEP 4A: Mounting a Horizontal Profile for Portrait Module Orientation	13
Option 2 – STEP 4B: Mounting a Vertical Profile for Landscape Module Orientation	13
Option 3 – STEP 4C: Mounting a Profile Grid for Landscape Module Orientation	14
STEP 5: Extending Profiles	14
STEP 6: Attaching PV Modules and Fixing with Clamps	15
Terms and Conditions	16

GENERAL REQUIREMENTS

The sole purpose of this installation manual is to demonstrate the installation of BISOL EasyMount™ mounting systems, therefore PV module installation guidelines and related safety precautions are not a part of this manual. For guidelines on how to safely and effectively install BISOL PV modules please refer to the PV installation manual, published on www.bisol.com.

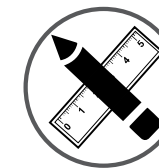

PV design:

The installer carries all responsibility for PV system dimensioning, static calculations of the roof, weather and environmental conditions at location, proper selection and use of components and their mounting as well as the mechanical durability and water tightness of the installed interface connections at the building surface. All safety warnings outlined in this manual are to be closely considered.



Roof:

The continual pressure loading capacity (point load) of the insulation and the roofing material must be checked thoroughly and found to be sound before installation. If the compression strength of the roof surface is not sufficient, extra support surfaces must be added.

The roof must be in good condition and strong enough to bear the weight of the solar panels, including associated materials, ballast, wind and snow load. The customer is responsible to check the stability of the roof structure and, when necessary, employ a builder to correct it.

The customer is responsible to check the compatibility of EasyMount™ Quick RAIL mounting materials with local climate conditions (salt, acidity, sulphates etc.) and roof materials. The types of materials used in the Quick RAIL are stated in the product datasheets.



Installation work:

All installation work must be carried out by a specialised company with qualified personnel. Strict safety and accident prevention measures as defined by relevant regulations must be carried out and should be known by the installer. Appropriate protective equipment for work at height must be used throughout the installation process.

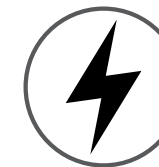

Electrical work:

Although electrical connections are strictly not part of this manual, some safety warnings are in place. PV modules and mounting structure must be grounded even when the site is already equipped with lightning protection. PV modules are under high voltage and generate electrical current even in low light conditions. When modules are connected in series, life-threatening voltage is present at the end of the terminals. Open circuited branches can cause electric arc when in touch with conductive surface. Electrical installations must not be carried out in case of dampness.

BISOL Production Ltd. does not accept responsibility and expressly disclaims liability for loss, damage, or expense arising out of or in any way connected to PV system design and dimensioning, installation work, operation, use or maintenance. A failure to adhere to the guidelines stated in this document and/or in the construction plan may void all guarantee and liability claims for the product. The information in this manual is based on BISOL Productin's knowledge and experience; but such information, including product specification (without limitations), and suggestions do not constitute a guarantee, express or implied. BISOL Production reserves the right to change the installation manual as well as product specifications without prior notice.

COMPONENTS OVERVIEW

	Component	ID Code	Component description
1		EM-H00.AT.1	Hook AI triple adjustable, V1
2		EM-H00.SD6.1	Hook steel double adjustable, 6 mm, V1
3		SEK-W65_100	Screw wood 6.5 x 100 mm EPDM
4		SEK-48_27_5400	EasyMount™ 48 x 27 x 5400 mm
5		SEK-48_27_2200	EasyMount™ 48 x 27 x 2200 mm
6		SEK-48_27_2200_B	EasyMount 48 x 27 x 2200 mm, Black
7		SEKP-EMC48	Connector set for EasyMount™ 48 x 27 mm
8		SEKP-EMC48_M	Connector set for EasyMount 48 x 27, Magnelis
9		EM-CLA.EA35S.2	Clamp end EasyMount™ 35 mm Direct, assembled
10		EM-CLA.MA35S.2	Clamp middle EasyMount™ 35 mm Direct, assembled
11		SEK-HHS_10_25	Screw hammerhead M10 x 25 A2-70
12		SEK-DIN6923_10	Nut M10 flange A2-70
13		SEK-EMLC	Connector L EasyMount™

TOOLS REQUIRED

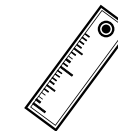

Measuring tool

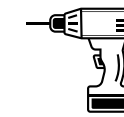

Electric drill



Torque wrench



Torx T30 socket



Angle grinder

PLANNING THE PV LAYOUT

Project Design

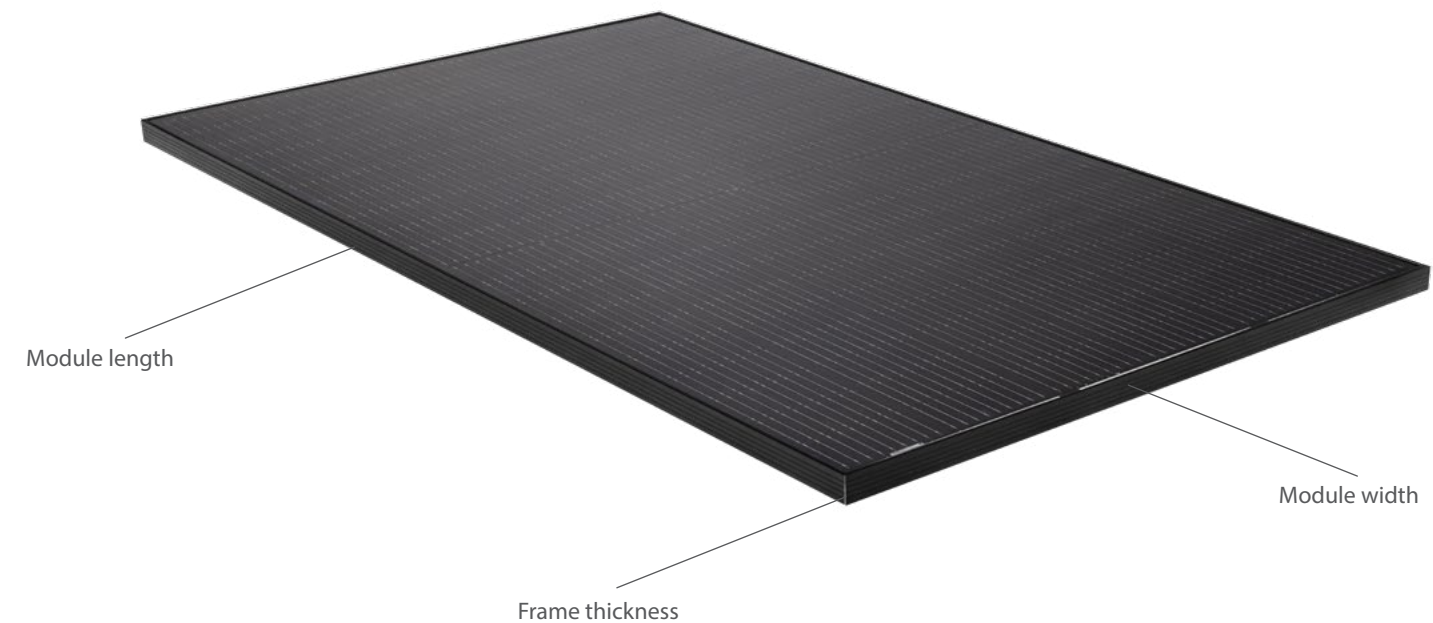



Designing the PV Module Layout

Portrait Orientation

Minimal horizontal block space required:

$$a = (\text{module width} + 20 \text{ mm}) * \text{number of modules in one row} + 60 \text{ mm}$$
$$a_{\text{max}} = 15 \text{ m}$$

Minimal vertical block space required:

$$b = (\text{module length} + 20 \text{ mm}) * \text{number of modules in one row} + 60 \text{ mm}$$
$$b_{\text{max}} = 15 \text{ m}$$

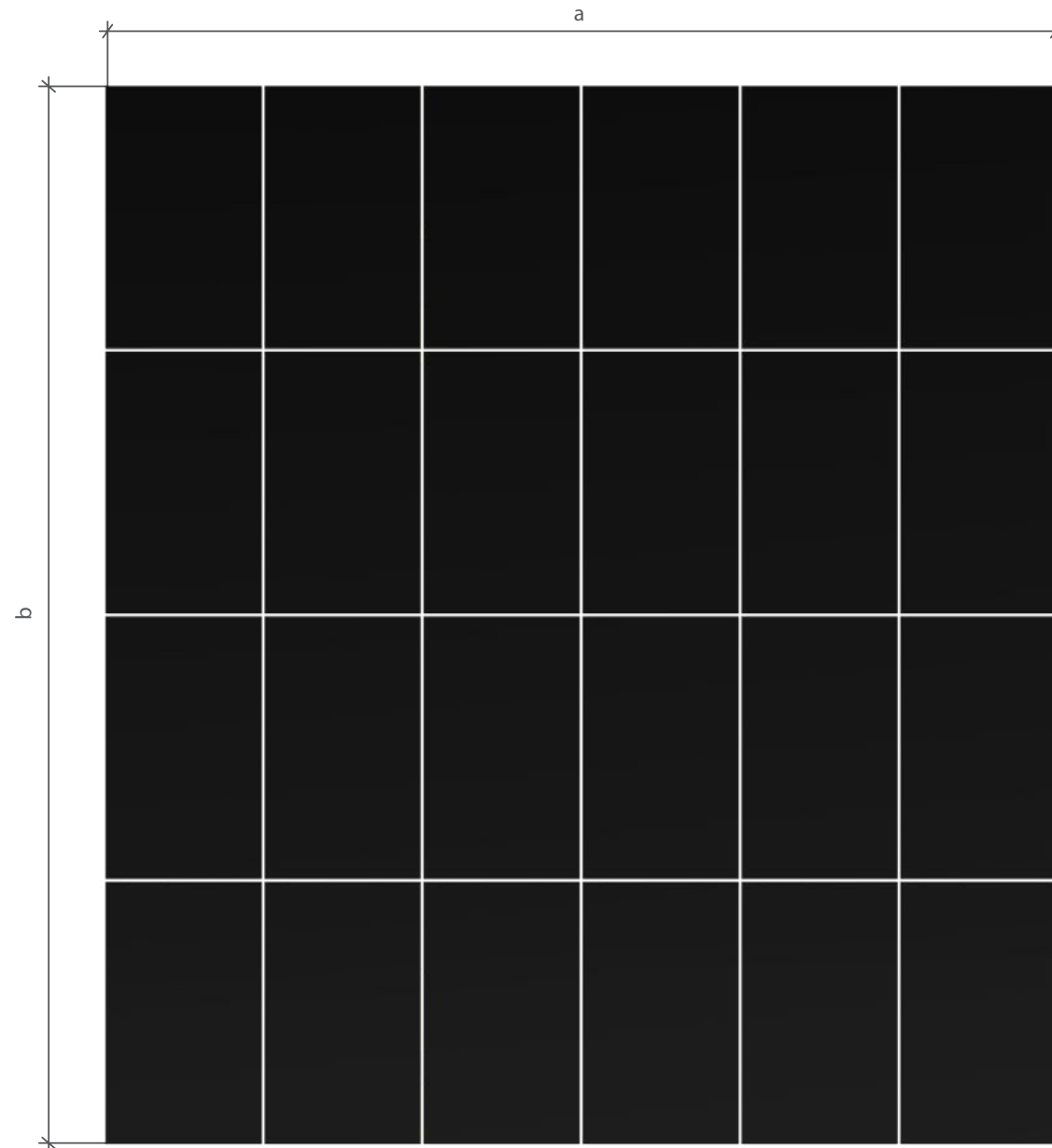

Landscape Orientation

Minimal horizontal block space required:

$$a = (\text{module width} + 20 \text{ mm}) * \text{number of modules in one row} + 60 \text{ mm}$$
$$a_{\text{max}} = 15 \text{ m}$$

Minimal vertical block space required:

$$b = (\text{module length} + 20 \text{ mm}) * \text{number of modules in one row} + 60 \text{ mm}$$
$$b_{\text{max}} = 15 \text{ m}$$



Important Dimensions for Module Fields and Thermal Separation

Portrait Orientation

$W_1 \geq 60 \text{ mm}$
 $W_2 \geq 60 \text{ mm}$

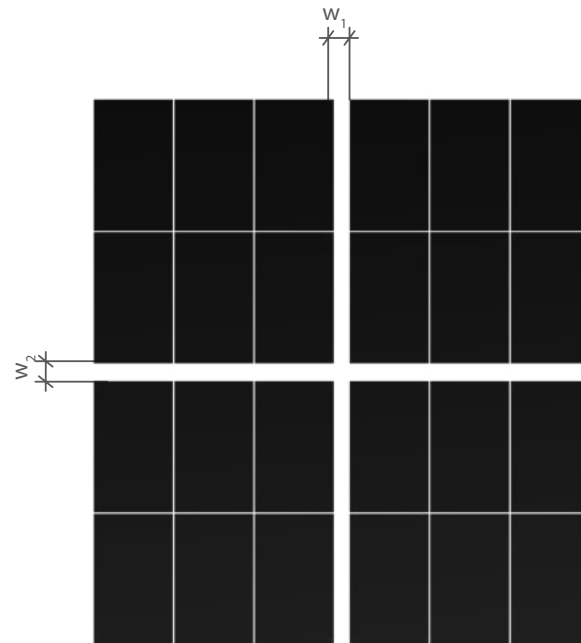

Landscape Orientation

$W_1 \geq 60 \text{ mm}$
 $W_2 \geq 60 \text{ mm}$

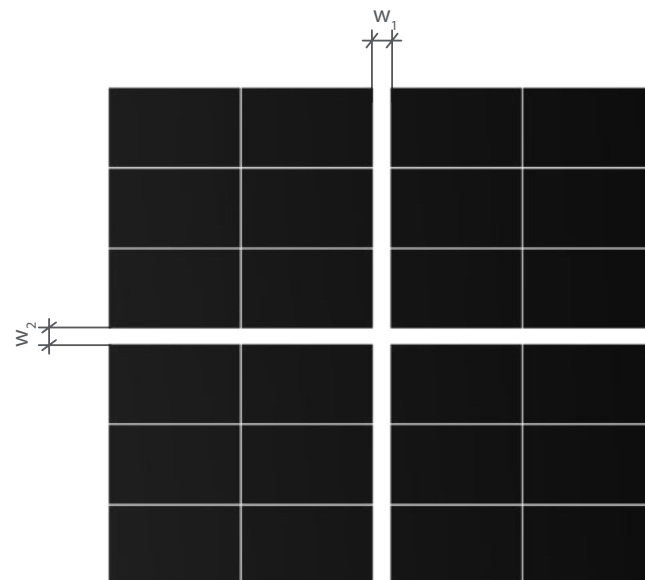

BISOL EasyMount™ Home HOOK mounting solution allows PV module installation in both portrait and landscape orientation. The layout examples below are shown for usage with standard sized BISOL PV modules. Please follow the guidelines of specific module manufacturers when using other PV module brands.

	Distance
A	< 40 cm
B	80 – 150 cm

	Span between rafters		
C	Any		85 cm ± 6.5 cm
Module orientation	Landscape	Portrait	Landscape
Solution	Profile 48 ⁽²⁾ / Grid (Profile 48 + Profile 48)	Profile 48	Profile 48 + L-connector

⁽²⁾ For modules that can be mounted on the short side of the frame.

Portrait module installation:

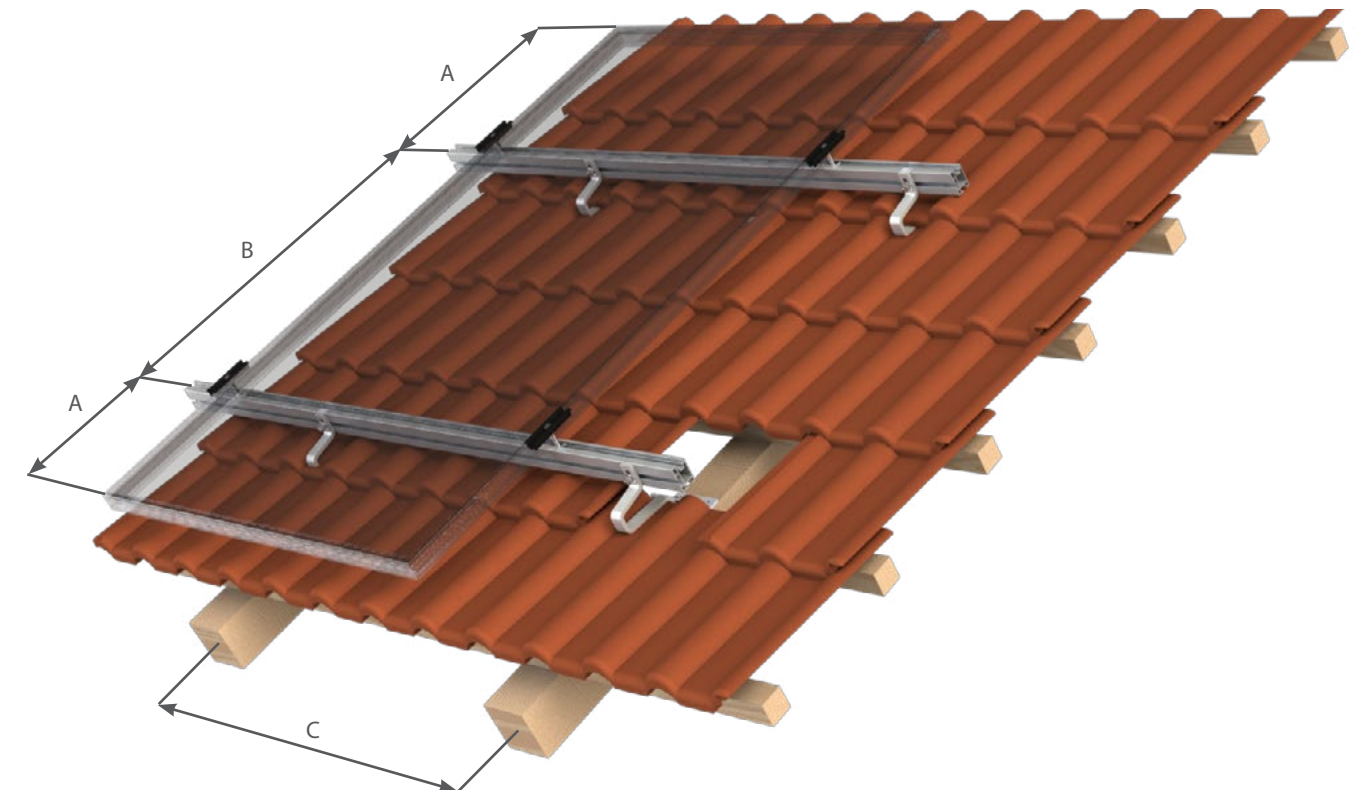

Landscape module installation (using a profile grid):

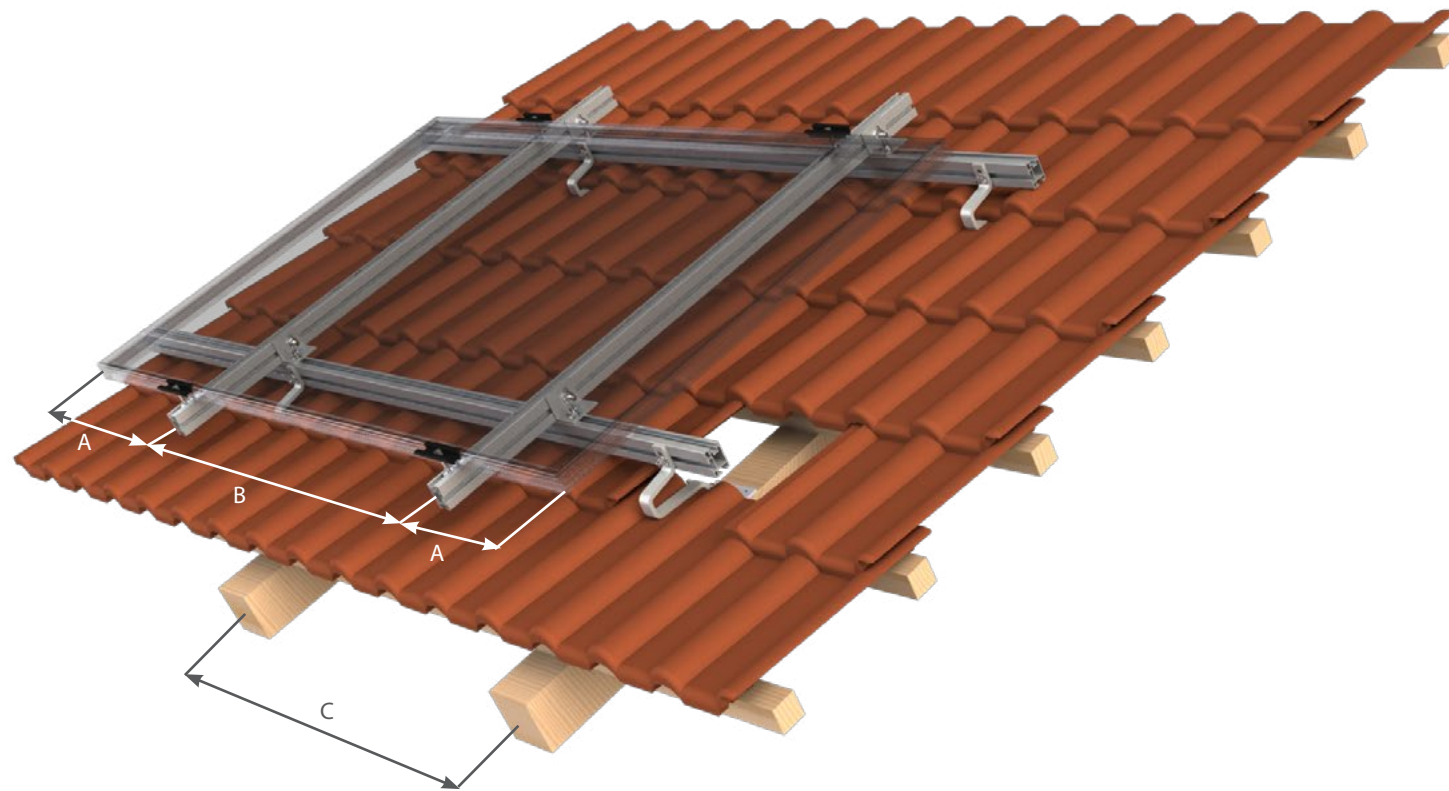

Landscape module installation (using the L-connector):

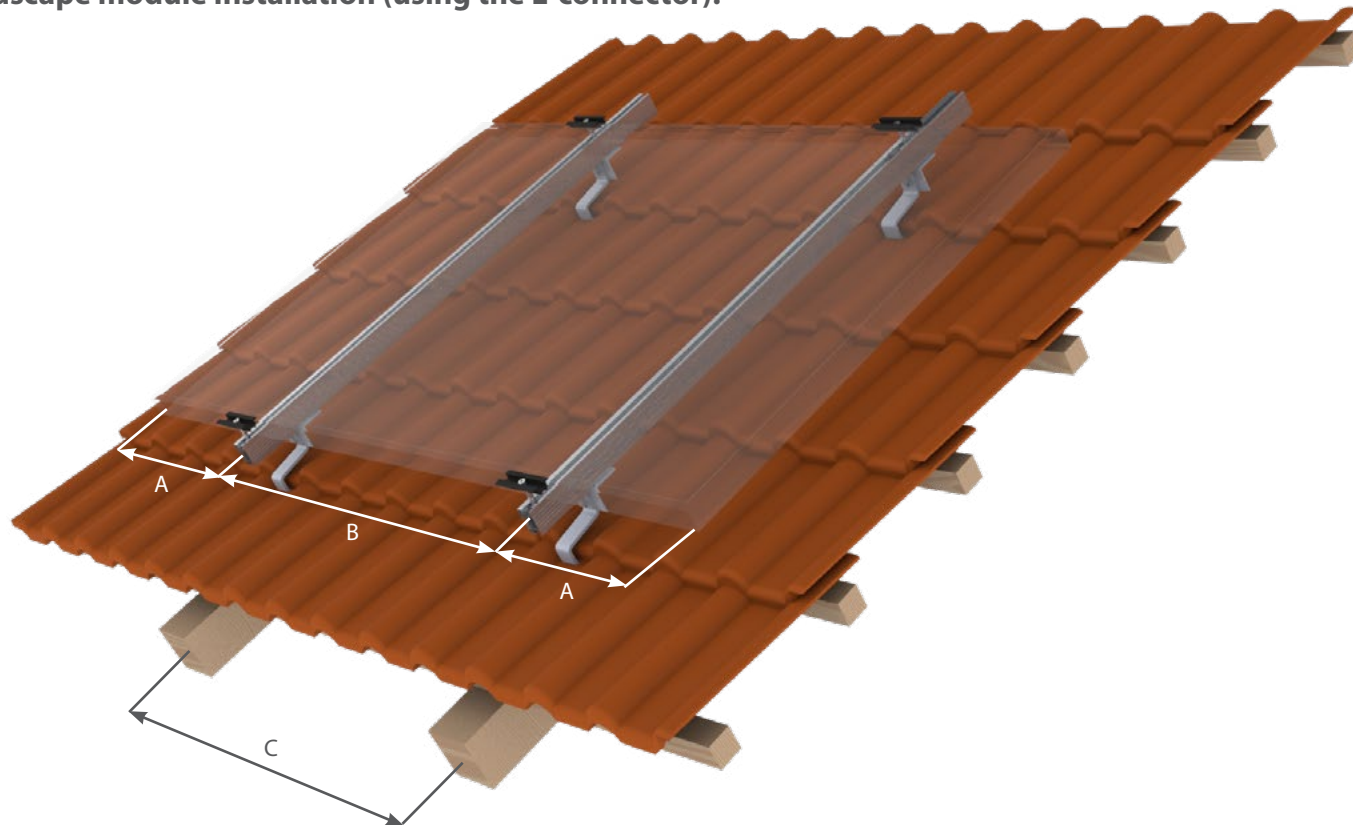

ASSEMBLY

STEP 1: Removing Tiles

Remove the tiles in places where the hooks will be attached to the wooden rafter.

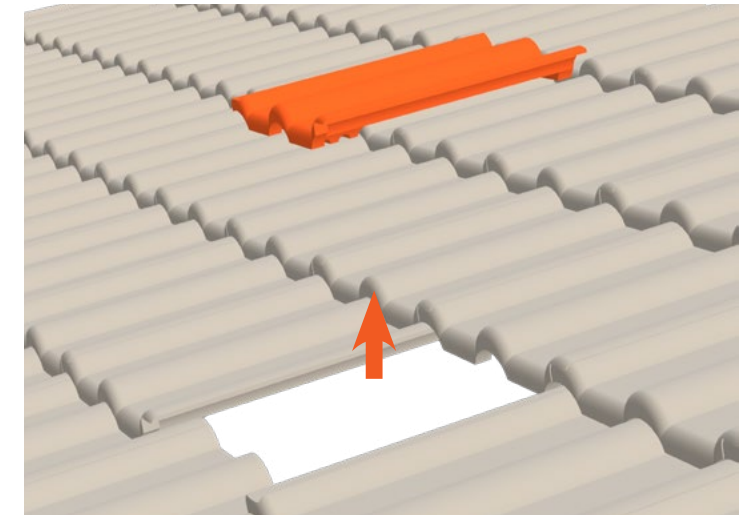

STEP 2: Mounting Hooks

Fix the hook to a wooden rafter using four wood screws with washers. The hook should be positioned between two tile waves as shown in the picture below, and elevated enough above the tile so it does not touch the tile when fully loaded.

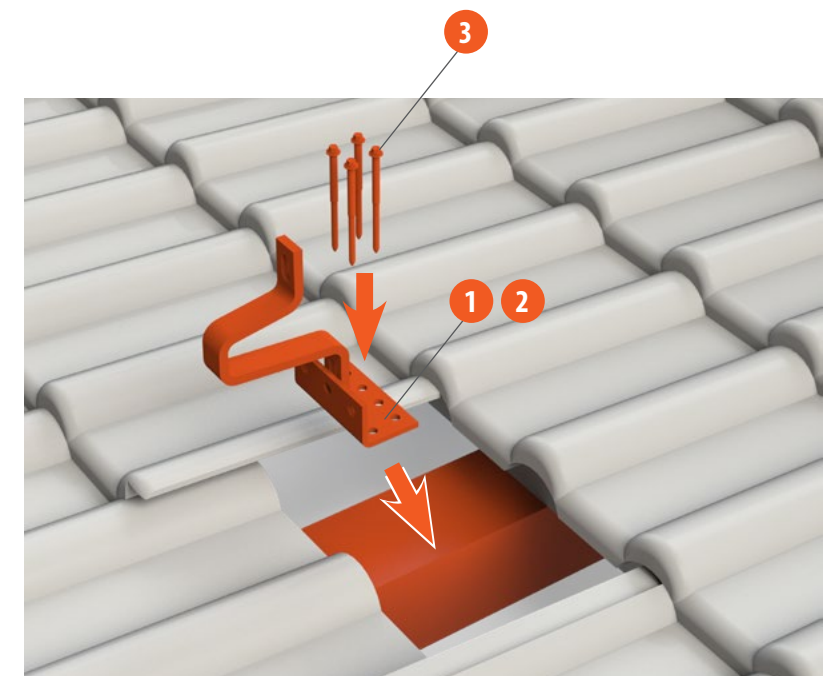

STEP 3: Trimming and Repositioning Tiles

Trim off some material from the bottom of the tile to allow the tile to fit better around the hook when it is repositioned in its original place. For trimming, use an angle grinder.

Trimmed material should be at least wide, long and deep enough for the tile not to touch the hook when repositioned.

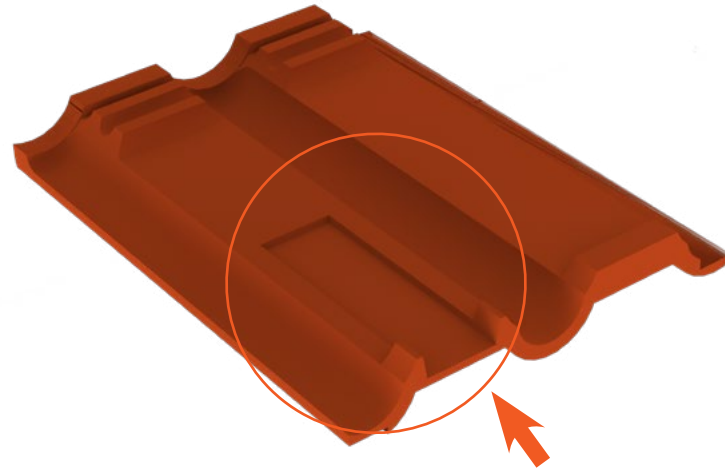

STEP 4: Mounting Profiles

Profiles can be mounted on the hook from the side or from the top as seen below.

TOP MOUNTING		SIDE MOUNTING
<ul style="list-style-type: none"> • Landscape module orientation • Span between rafters⁽³⁾: 85 cm ± 6.5 cm <p><small>⁽³⁾ For usage with standard sized BISOL modules</small></p>	<ul style="list-style-type: none"> • Portrait module orientation • More height adjustability in case of uneven roofs • Bigger gap between the PV modules and the roof surface 	<ul style="list-style-type: none"> • Portrait module orientation • As a base for profile grid in case of landscape module orientation

Option 1 – STEP 4A: Mounting a Horizontal Profile for Portrait Module Orientation

Mount the EasyMount™ 48 profile horizontally onto the hooks using screws and flange nuts, and applying a torque of 22 Nm.

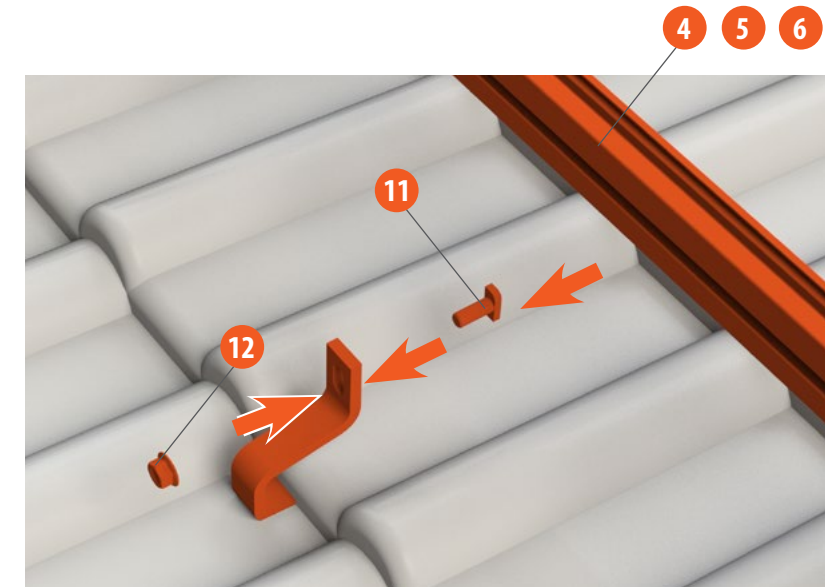

Option 2 – STEP 4B: Mounting a Vertical Profile for Landscape Module Orientation

Mount the EasyMount™ 48 profile vertically onto the L-connector on the hook using screws and flange nuts, and applying a torque of 22 Nm.

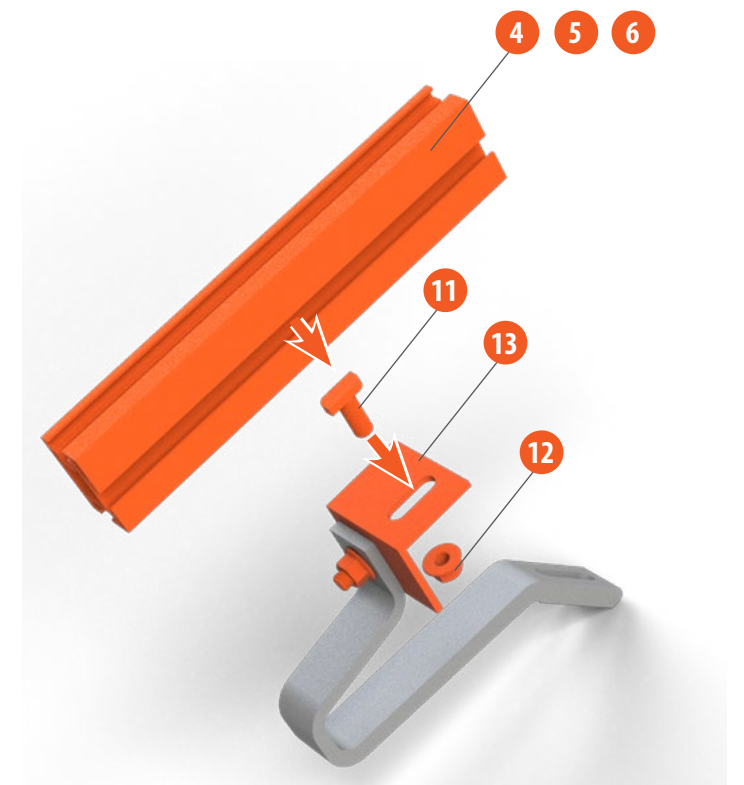

Option 3 – STEP 4C: Mounting a Profile Grid for Landscape Module Orientation

After mounting the EasyMount™ 48 profile horizontally onto the hook, as described in STEP 4A, continue to mount the EasyMount™ 48 profiles vertically and connect the intersecting EasyMount™ 48 profile with the L-connector using screws and flange nuts, and applying a torque of 22 Nm.

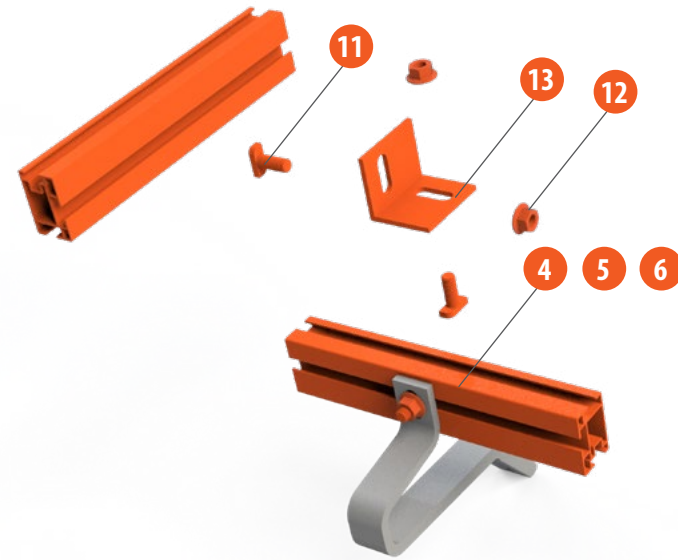
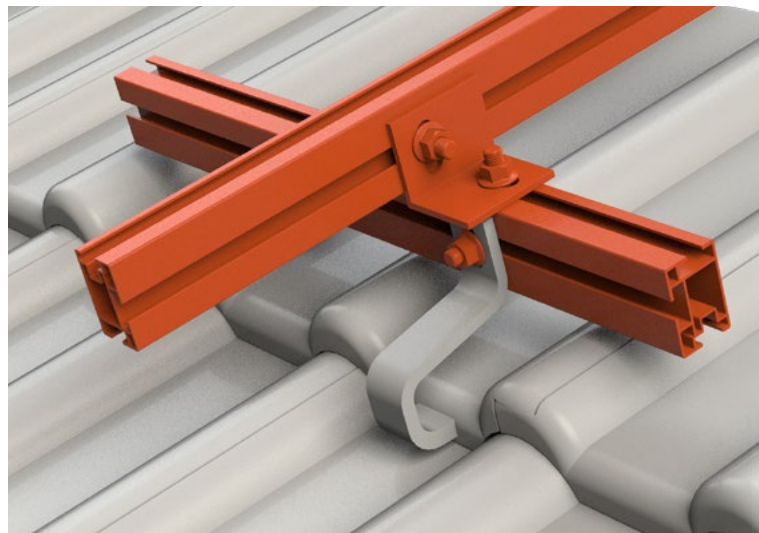

STEP 5: Extending Profiles

If needed, extend the profiles by using the connector set. Mount the connector below the EasyMount™ 48 profile and fix it with screws. Connector set is delivered pre-assembled with two sets of screws.

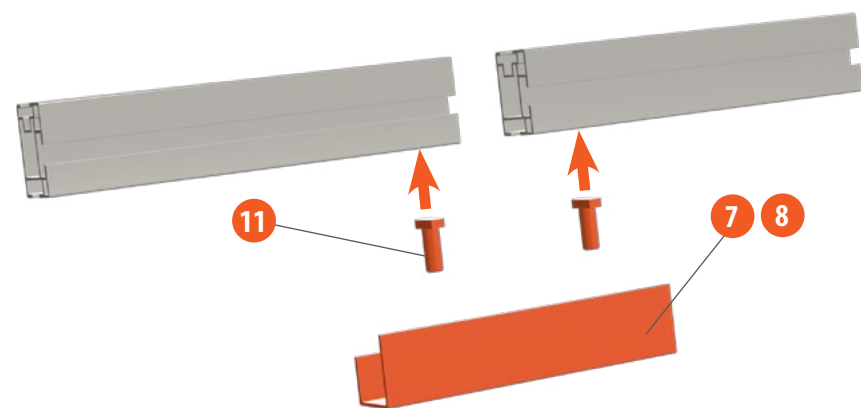

STEP 6: Attaching PV Modules and Fixing with Clamps

Insert the lower part of the clamp (end or middle) into the top slot of the EasyMount™ 48 profile and rotate by 90°. Lay the PV modules on the profiles and fix them with the clamps applying a torque of 10 Nm.

End clamps are used at the ends of each row, while the middle clamps fixate two adjoining modules in the same row. All clamps are delivered pre-assembled.

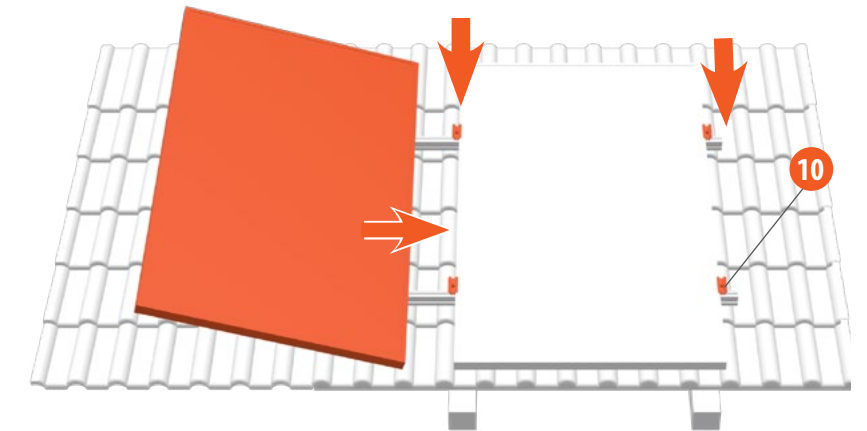

TERMS AND CONDITIONS

BISOL Production Ltd. as manufacturer of BISOL EasyMount™ mounting solutions in connection with their installation takes no responsibility for the design solutions of individual designers, also assumes no responsibility in connection with the installation of BISOL EasyMount™ mounting solutions by a third party and contrary to these instructions, as well as for the choice of mounting structure in this regard.

BISOL Production Ltd. does not accept liability and expressly disclaims liability for loss, damage or costs arising from or in any way related to the design and dimensioning, installation work, operation, use or maintenance of the solar system.

Failure to follow the guidelines set out in this document and / or in the construction plan may invalidate all claims for product guarantees and liabilities.

The information in this manual is based on the knowledge and experience of the BISOL Production Ltd., but such information, including product specifications (without limitation), and suggestions do not constitute guarantees, expressed or implied. BISOL Production Ltd. reserves the right to change the installation instructions and product specifications without prior notice. The most recent version of this installation manual is published on official website www.bisol.com.

In addition, our General Sales Terms and Conditions for Supply of Goods and Services (GSTC) as well as Standard Limited Guarantee terms and conditions for mounting systems, both published on the website www.bisol.com, apply.



BISOL Production, Ltd.

🏠 Latkova vas 59a | SI-3312 Prebold | Slovenia

☎ +386 (0)3 703 22 50

✉ info@bisol.com

🌐 www.bisol.com

